

FÖRKLARINGAR

Fönster och fönsterdörrar ses från utsidan.
 Alla mått anges i millimeter.

beteckningar:
 v = vänsterhängd
 h = högerhängd

Kannummer anger:
 1 Sort enl Sv. Riksb ygens standard

FÖRESKRIFTER

Samtliga fönster och fönsterdörrar skall märkas enl denna ritnings
 litterering med tillagt v eller h.
 Snickerierna utförs i den kvalitet och med de beslag som är angivna
 i Sv riksb ygens standard X31-021 samt enl detaljer blad X31-025.
 Infästning enl A-ritn A5:5, A5:6.
 Beslag som kan skadas eller skada snickerierna under transport monteras
 på platsen.

Ytbehandling

Snickerierna färdigbehandlas på fabrik, enl SRS P21-001.
 Kulör: NCS 0500 vit

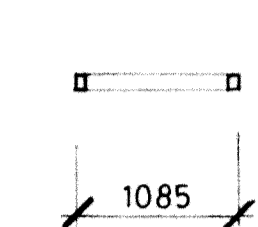
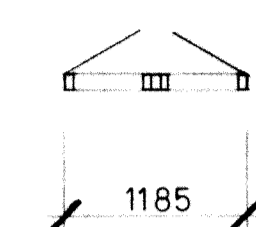
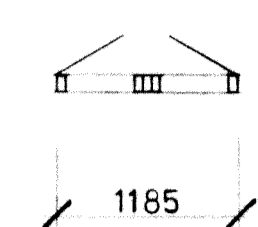
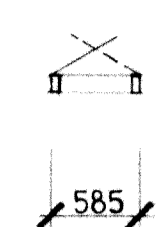
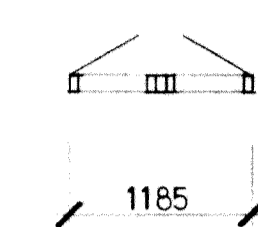
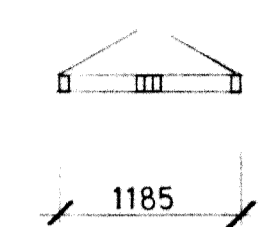
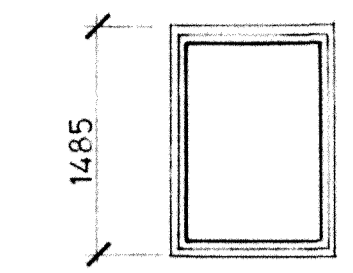
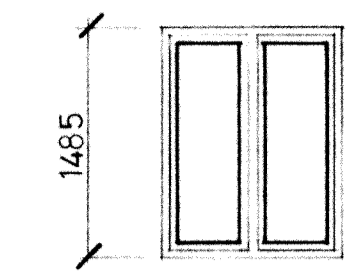
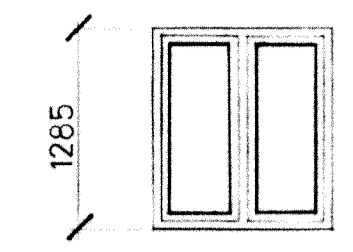
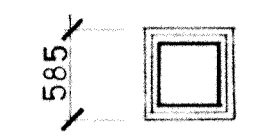
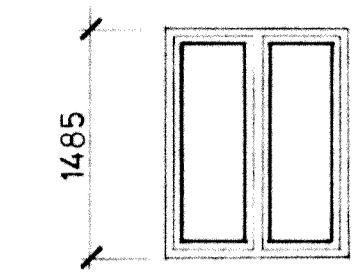
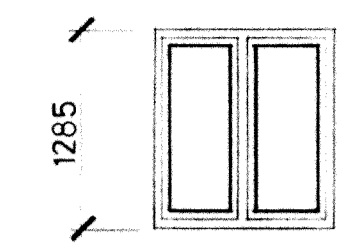

F 1 ANTAL: 279 st
 1. E1213

F 2 ANTAL: 73 st
 1. E1215

F 3 ANTAL: 32 v, 48 h
 1. A66

F 4 ANTAL: 23 st
 1. E1213 i princip
 glas: ytterbåge 8 mm
 maskinglas, innerbåge
 enl Sv. Riksb standard

F 5 ANTAL: 5 st
 1. E1215 i princip
 glas: ytterbåge 8 mm
 maskinglas, innerbåge
 enl Sv. Riksb standard

F 6 ANTAL: 5 st
 1. C1215 i princip
 mått enl figur

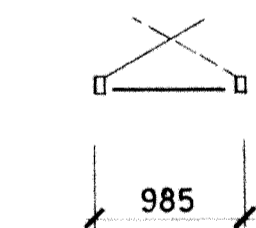
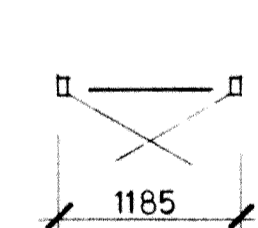
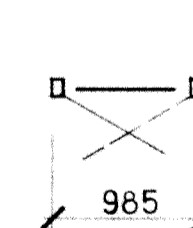
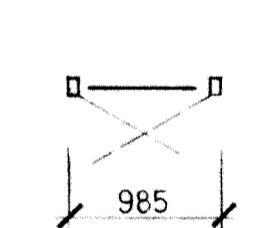
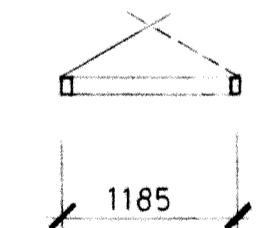
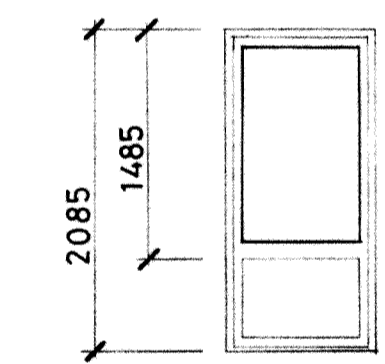
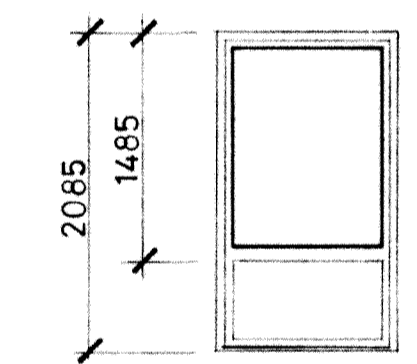
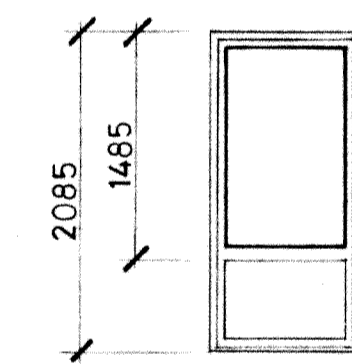
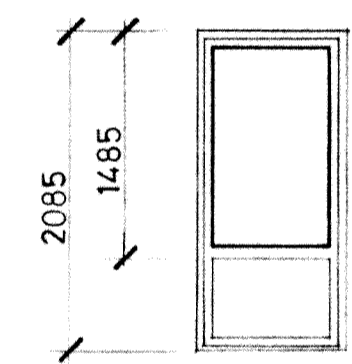
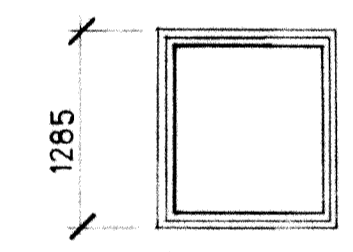

F 7 ANTAL: 1 v
 1. 1213

FD 1
 FD1a ANTAL: 11v, 9h
 1. DB15F
 FD1b ANTAL: 19v, 34h
 1. DB15F i princip
 Kompl med läsbar cylinder

FD 2 ANTAL: 5h
 1. DB15F i princip
 glas: ytterbåge 8 mm
 maskinglas, innerbåge
 2 x 4 mm maskinglas med
 12 mm luftspält

FD 3 ANTAL: 1 h
 1. DB15F i princip
 mått enl figur
 glas: ytterbåge 4 mm
 maskinglas, innerbåge
 2 x 4 mm maskinglas med
 12 mm luftspält

FD 4 ANTAL: 11v, 9h
 1. DB15F i princip
 inåtgående

RIKSBYGGEN
 PROJEKTERINGSKONTORET I MALMÖ
 STADIONGATAN 10 TEL 040-801 60
 BOX 8057 200 41 MALMÖ

white
 White arkitekter AB • Malmö
 Västergatan 23 • 211 21 Malmö • Tel 040-776 90

HANDLÄGGANDE
 S ERIKSSON A REVELLÉ
 MALMÖ81-02-20

REG ANT REGISTRERING AVSER SIGN DATUM
 A 1 F3 HS 82-08-06

KÄVLINGE
 BOGESHOLMSOMRÅDET
 KÄVLINGE 7
 FÖNSTER, FÖNSTERDÖRRAR
 SKALA 1:50

KOD TYP POS RITINGSNR REG
 A6:1 A

Sten Järlberg